

DIODE MODULE (F.R.D.)

MDF(R)150A-L/M

MDF(R)150A-L/M and MDR150-L/M are high speed (fast recovery) diode with flat mounting base which is designed for switching application of high power.

- $I_{F(AV)} = 150A$ $V_{RRM} = 200/300/400V$
- Easy Construction with Anode (F) Type and Cathode (R) Type
- Reverse Recovery Time (t_{rr}) L Type: 450ns, M Type: 550ns
- Highly Reliability by Grass passivated Chips
- Non isolated type

[MDF: anode to terminal (normal polarity)
MDR: cathode to terminal]

(Applications)

Switching Power Supply.
Inverter Welding Power Supply

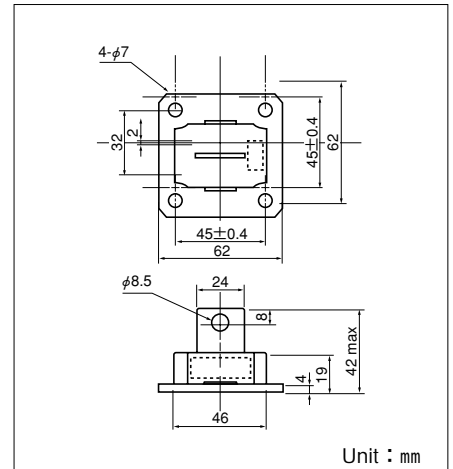
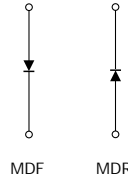

Unit : mm

Maximum Ratings

($T_j = 25^\circ C$ unless otherwise specified)

Symbol	Item	Ratings			Unit
		MDF(R)150A20L/M	MDF(R)150A30L/M	MDF(R)150A40L/M	
V_{RRM}	Repetitive Peak Reverse Voltage	200	300	400	V
V_{RMS}	Non-Repetitive Peak Reverse Voltage	240	360	480	V
$V_{R(DC)}$	D.C. Reverse Voltage	160	240	320	V

Symbol	Item	Conditions	Ratings	Unit	
$I_{F(AV)}$	Average Forward Current	Single phase, half wave, 180° conduction, $T_c: 94^\circ C$	150	A	
$I_{F(RMS)}$	R.M.S. Forward Current	Single phase, half wave, 180° conduction, $T_c: 94^\circ C$	235	A	
I_{FMS}	Surge Forward Current	$1\frac{1}{2}$ cycle, 50/60Hz, peak value, non-repetitive	2700/3000	A	
I^2t	I^2t	Value for one cycle of surge current	37500	A ² S	
T_j	Operating Junction Temperature		-30 to +150	$^\circ C$	
T_{stg}	Storage Temperature		-30 to +125	$^\circ C$	
	Mounting Torque	Mounting (M6)	Recommended Value 2.5-3.9 (25-40)	4.7 (48)	N·m (kgf·cm)
		Terminal (M8)	Recommended Value 8.8-10 (90-105)	11 (115)	
	Mass	Typical Value	170	g	

Electrical Characteristics

Symbol	Item	Conditions	Ratings	Unit	
I_{RRM}	Repetitive Peak Reverse Current (max.)	at V_{RRM} , single phase, half wave, $T_j = 150^\circ C$	50	mA	
V_{FM}	Forward Voltage Drop (max.)	Forward current 470A, $T_j = 25^\circ C$ Inst. measurement	1.30	V	
$R_{th(j-c)}$	Thermal Impedance max (max.)	Junction to case	0.30	$^\circ C/W$	
t_{rr}	Reverse Recovery Time (max.)	$T_j = 25^\circ C$, $I_F = 2A$, $-di/dt = 20A/\mu s$	L	450	ns
			M	550	

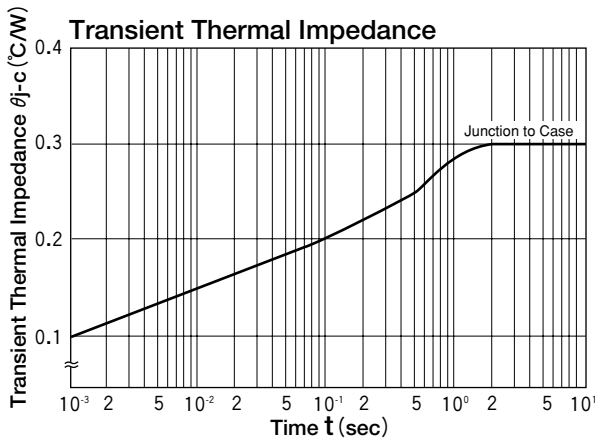
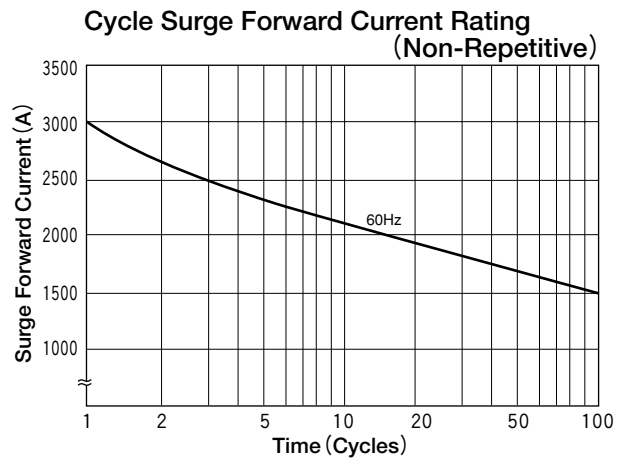
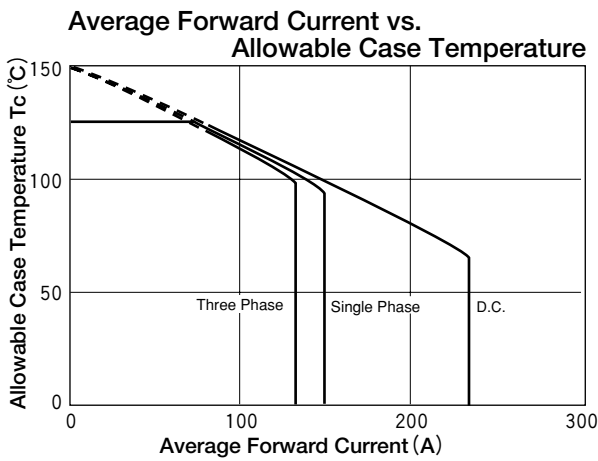
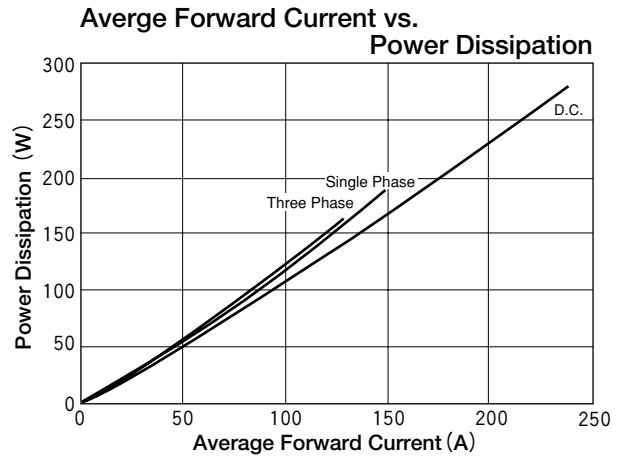
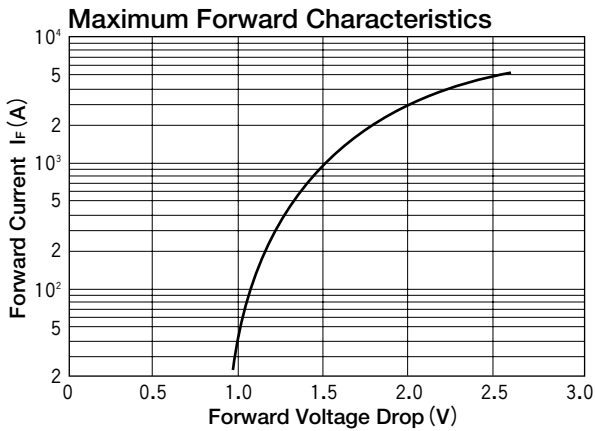

This datasheet has been download from:

www.datasheetcatalog.com

Datasheets for electronics components.