

### Dual IGBTMOD™ Compact IGBT Series Module 600 Amperes/1200 Volts

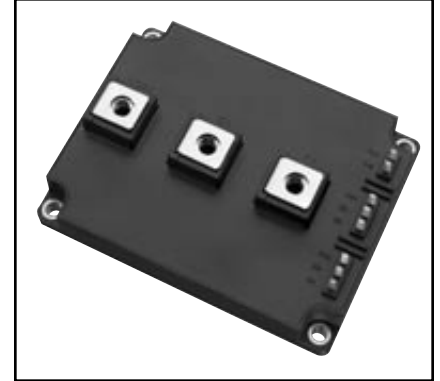
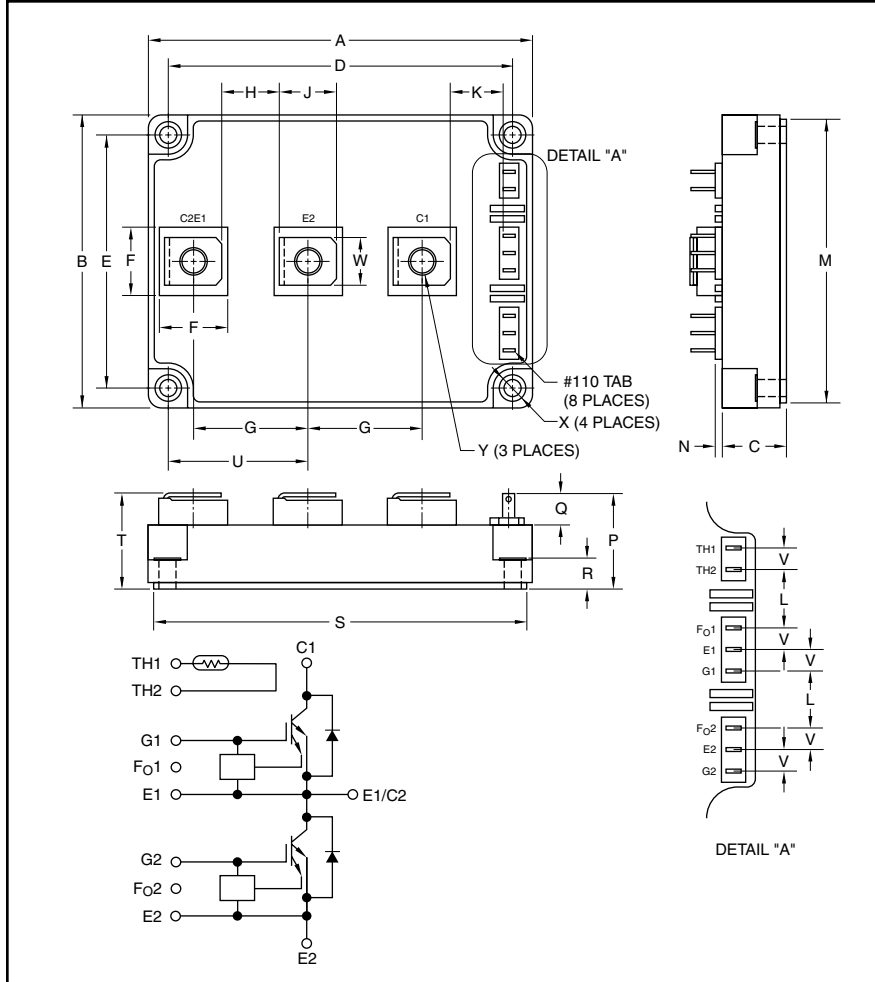

#### Description:

Powerex Dual IGBTMOD™ Compact IGBT Series Modules are designed for use in switching applications. Each module consists of two IGBT Transistors in a half-bridge configuration, with each transistor having a reverse-connected super-fast recovery free-wheel diode. All components and interconnects are isolated from the heat sinking baseplate, offering simplified system assembly and thermal management.

#### Features:

- Over-Current and Over-Temperature Protection
- Low  $V_{CE(sat)}$
- Isolated Baseplate for Easy Heat Sinking

#### Applications:

- AC Motor Control
- Motion/Servo Control
- UPS
- Welding Power Supplies
- Laser Power Supplies

#### Ordering Information:

Example: Select the complete part number from the table below -i.e. MG600Q2YS60A is a 1200V ( $V_{CES}$ ), 600 Ampere Dual IGBTMOD™ Compact IGBT Series Module.

Type	Current Rating Amperes	$V_{CES}$ Volts (x 10)
MG	600	120

#### Outline Drawing and Circuit Diagram

Dimensions	Inches	Millimeters
A	4.92±0.04	125.0±1.0
B	3.78±0.04	96.0±1.0
C	0.84±0.04	21.3±1.0
D	4.49±0.03	113.0±0.8
E	3.30±0.03	84.0±0.8
F	0.86±0.04	22.0±1.0
G	1.46±0.04	37.0±1.0
H	0.75±0.04	19.0±1.0
J	0.71±0.04	18.0±1.0
K	0.73±0.04	18.6±1.0
L	0.59±0.04	15.0±1.0
M	3.66±0.03	93.0±0.8

Dimensions	Inches	Millimeters
N	0.07±0.04	1.8±1.0
P	1.24±0.04	31.5±1.0
Q	0.40±0.03	10.2±0.8
R	0.34±0.03	8.7±0.8
S	4.92±0.04	125.0±1.0
T	1.24-0.01/+0.04	31.5+2.0/-0.8
U	1.81±0.04	46.0±1.0
V	0.22±0.04	5.6±1.0
W	0.63±0.03	16.0±0.8
X	0.21 Dia.	5.5 Dia.
Y	M8 Metric	M8



Powerex, Inc., 200 E. Hillis Street, Youngwood, Pennsylvania 15697-1800 (724) 925-7272

**MG600Q2YS60A**  
**Dual IGBTMOD™**  
**Compact IGBT Series Module**  
 600 Amperes/1200 Volts

**Absolute Maximum Ratings,  $T_j = 25^\circ\text{C}$  unless otherwise specified**

Characteristics	Symbol	MG600Q2YS60A	Units
Collector-Emitter Voltage	$V_{CES}$	1200	Volts
Gate-Emitter Voltage	$V_{GES}$	$\pm 20$	Volts
Collector Current (DC)	$I_C$	600	Amperes
Forward Current (DC)	$I_F$	600	Amperes
Collector Dissipation ( $T_C = 25^\circ\text{C}$ )	$P_C$	4300	Watts
Power Device Junction Temperature	$T_j$	-20 to 150	$^\circ\text{C}$
Storage Temperature	$T_{stg}$	-40 to 125	$^\circ\text{C}$
Mounting Torque, M5 Mounting Screws	—	27	in-lb
Mounting Torque, M8 Main Terminal Screws	—	88	in-lb
Module Weight (Typical)	—	680	Grams
Isolation Voltage, AC 1 minute, 60Hz Sinusoidal	$V_{ISO}$	2500	Volts

**Electrical and Mechanical Characteristics,  $T_j = 25^\circ\text{C}$  unless otherwise specified**

Characteristics	Symbol	Test Conditions	Min.	Typ.	Max.	Units
Gate Leakage Current	$I_{GES}$	$V_{GE} = \pm 20\text{V}, V_{CE} = 0\text{V}$	—	—	$\pm 10$	$\mu\text{A}$
Collector Cutoff Current	$I_{CES}$	$V_{CE} = 1200\text{V}, V_{GE} = 0\text{V}$	—	—	1.0	mA
Gate-Emitter Cutoff Voltage	$V_{GE(off)}$	$I_C = 600\text{mA}, V_{CE} = 5\text{V}$	6.0	6.7	8.0	Volts
Collector-Emitter Saturation Voltage	$V_{CE(sat)}$	$V_{GE} = 15\text{V}, I_C = 600\text{A}, T_j = 25^\circ\text{C}$	—	2.7	3.1	Volts
		$V_{GE} = 15\text{V}, I_C = 600\text{A}, T_j = 125^\circ\text{C}$	—	3.2	3.5	Volts
Input Capacitance	$C_{ies}$	$V_{CE} = 10\text{V}, V_{GE} = 0\text{V}, f = 1\text{MHz}$	—	41000	—	pF
Gate-Emitter Voltage	$V_{GE}$		13.0	15.0	17.0	Volts
Gate Resistance	$R_G$		7.5	—	15.0	$\Omega$
Inductive Load	$t_{d(on)}$		—	0.3	—	$\mu\text{s}$
Switching	$t_r$		—	0.2	—	$\mu\text{s}$
Times	$t_{on}$	$V_{CC} = 600\text{V}, I_C = 600\text{A},$	—	0.5	—	$\mu\text{s}$
	$t_{d(off)}$	$V_{GE} = \pm 15\text{V}, R_G = 7.5\Omega$	—	1.3	—	$\mu\text{s}$
	$t_f$		—	0.1	0.3	$\mu\text{s}$
	$t_{off}$		—	1.4	—	$\mu\text{s}$
Forward Voltage	$V_F$	$I_F = 600\text{A}, V_{GE} = 0\text{V}, T_j = 25^\circ\text{C}$	—	2.2	3.2	Volts
		$I_F = 600\text{A}, V_{GE} = 0\text{V}, T_j = 125^\circ\text{C}$	—	2.0	—	Volts
Reverse Recovery Time	$t_{rr}$	$I_F = 600\text{A}, V_{GE} = -15\text{V}, di/dt = 2000\text{A}/\mu\text{s}$	—	0.3	0.5	$\mu\text{s}$
Junction to Case Thermal Resistance	$R_{th(j-c)Q}$	IGBT (Per 1/2 Module)	—	—	0.029	$^\circ\text{C}/\text{Watt}$
	$R_{th(j-c)D}$	FWDi (Per 1/2 Module)	—	—	0.056	$^\circ\text{C}/\text{Watt}$
RTC Operating Current	$I_{rtc}$	$T_j = 25^\circ\text{C}$	1200	—	—	Amperes



Powerex, Inc., 200 E. Hillis Street, Youngwood, Pennsylvania 15697-1800 (724) 925-7272

**MG600Q2YS60A**  
**Dual IGBTMOD™**  
**Compact IGBT Series Module**  
 600 Amperes/1200 Volts

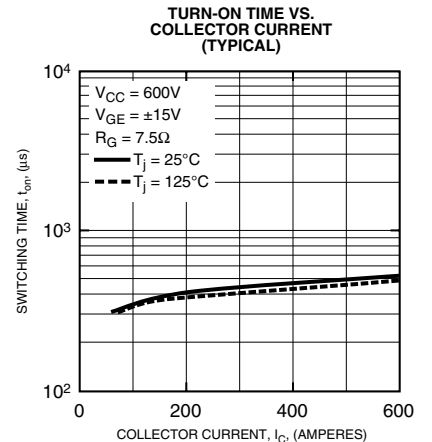
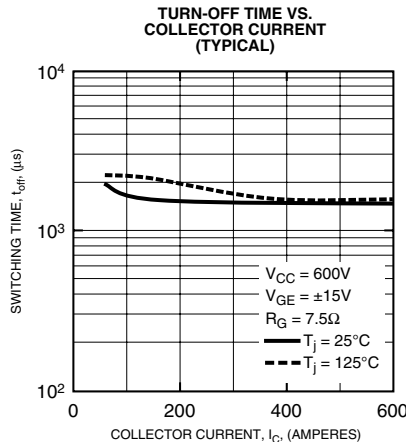
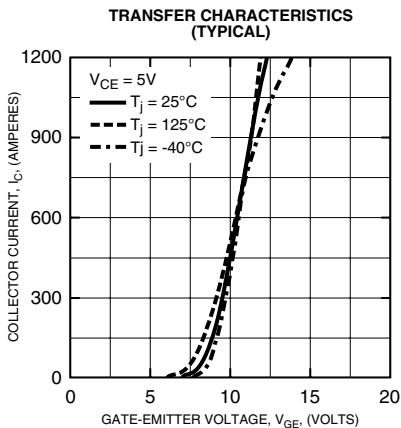
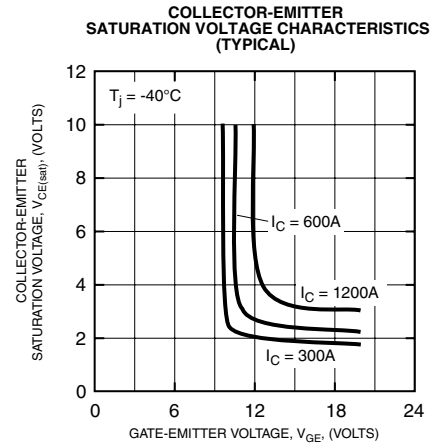
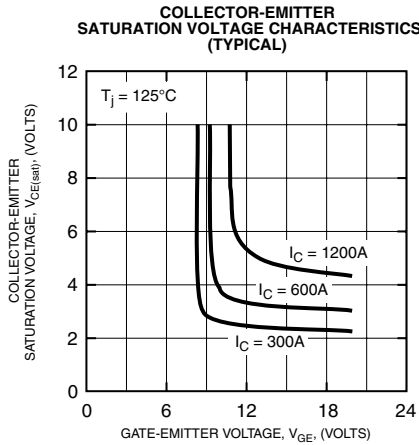
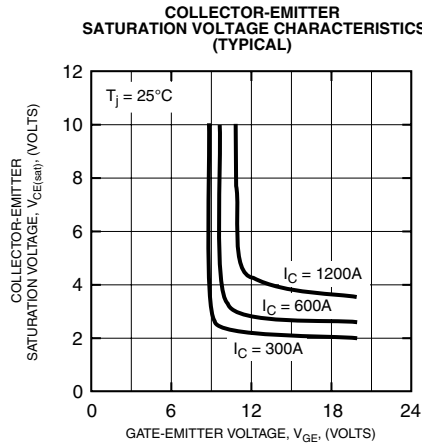
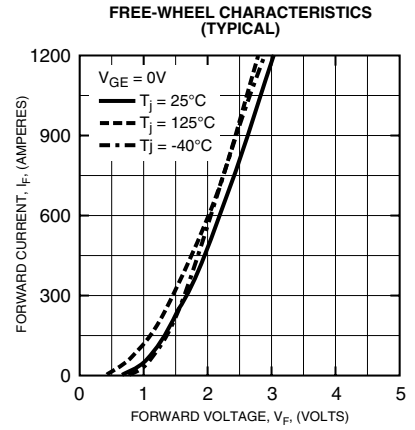
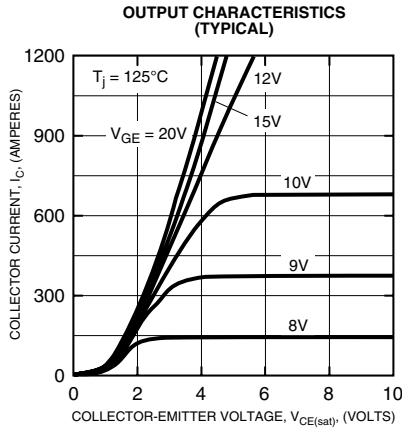
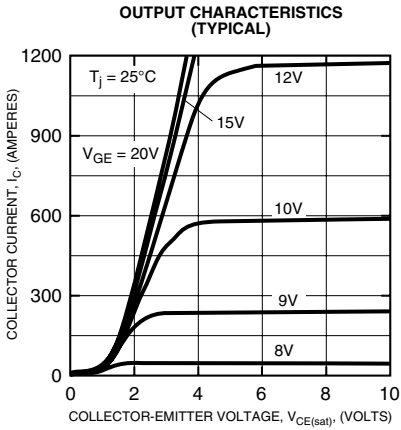



Powerex, Inc., 200 E. Hillis Street, Youngwood, Pennsylvania 15697-1800 (724) 925-7272

**MG600Q2YS60A**  
**Dual IGBTMOD™**  
**Compact IGBT Series Module**  
 600 Amperes/1200 Volts

**TURN-OFF DELAY TIME VS. COLLECTOR CURRENT (TYPICAL)**

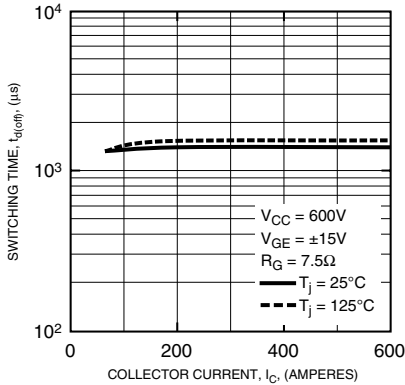

**TURN-ON DELAY TIME VS. COLLECTOR CURRENT (TYPICAL)**

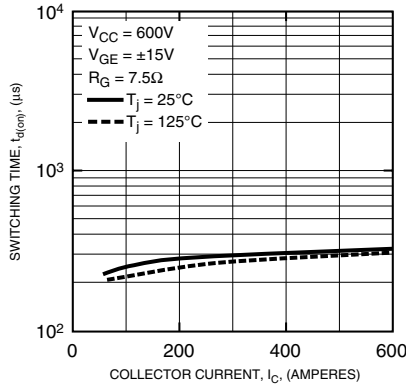

**FALL TIME VS. COLLECTOR CURRENT (TYPICAL)**

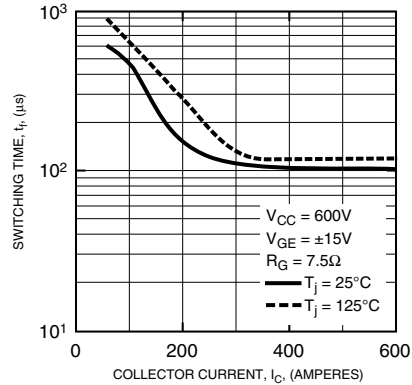

**RISE TIME VS. COLLECTOR CURRENT (TYPICAL)**

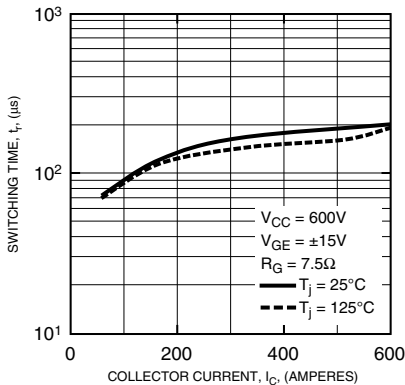

**TURN-OFF TIME VS. GATE RESISTANCE (TYPICAL)**

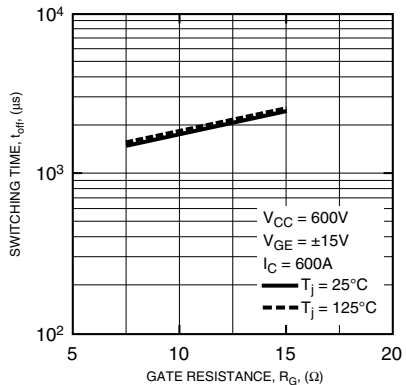

**TURN-ON TIME VS. GATE RESISTANCE (TYPICAL)**

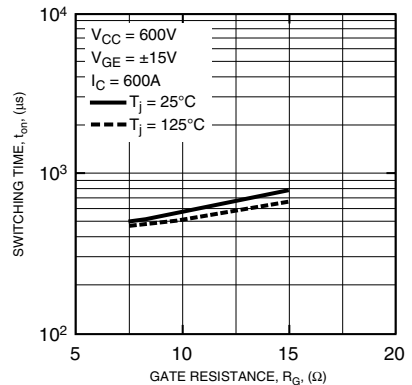

**TURN-OFF DELAY TIME VS. GATE RESISTANCE (TYPICAL)**

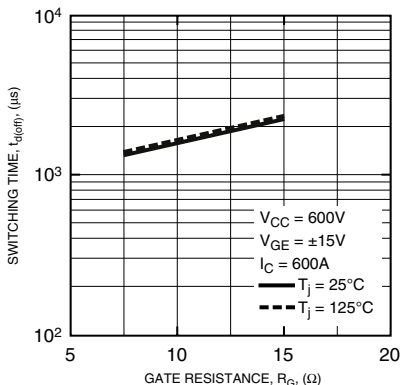

**TURN-ON DELAY TIME VS. GATE RESISTANCE (TYPICAL)**

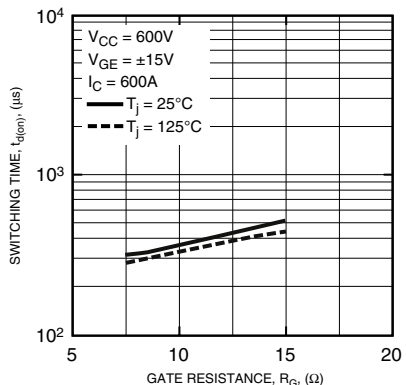

**FALL TIME VS. GATE RESISTANCE (TYPICAL)**

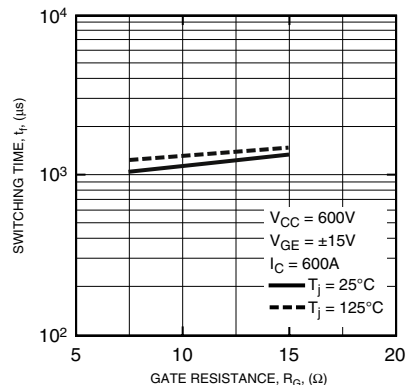



Powerex, Inc., 200 E. Hillis Street, Youngwood, Pennsylvania 15697-1800 (724) 925-7272

**MG600Q2YS60A**  
**Dual IGBTMOD™**  
**Compact IGBT Series Module**  
**600 Amperes/1200 Volts**

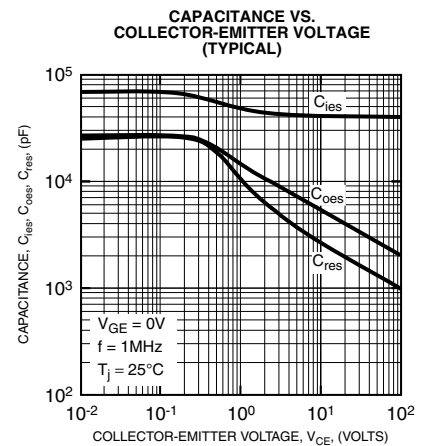
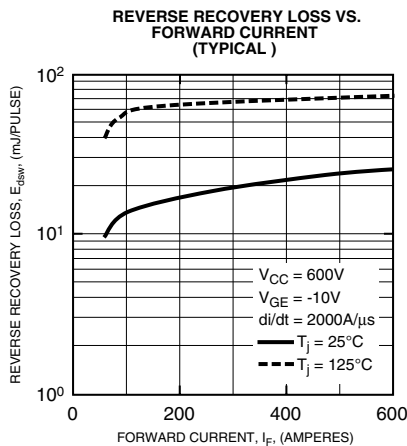
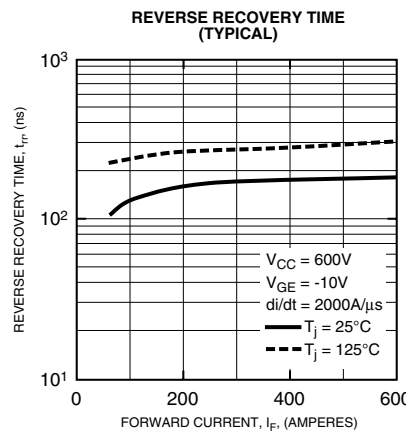
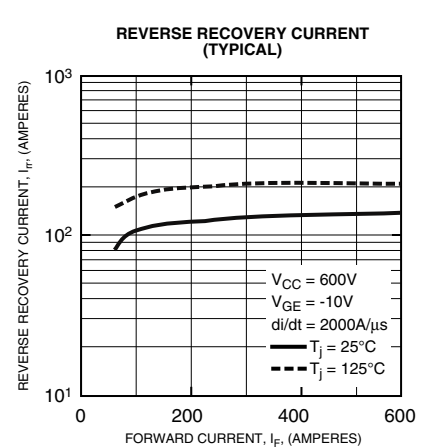
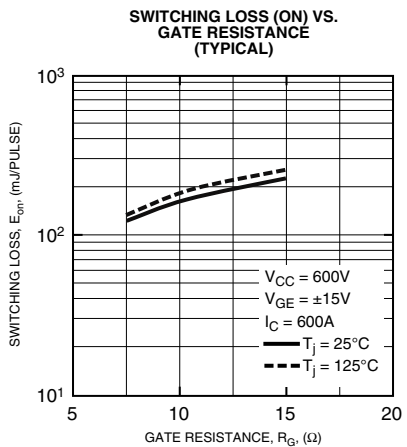
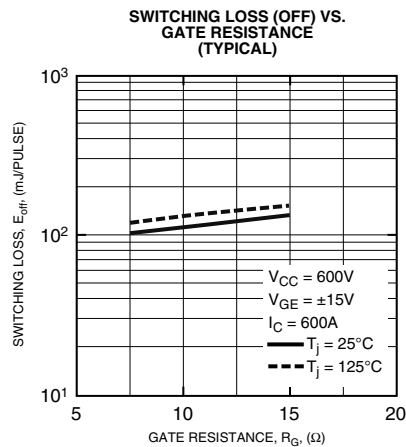
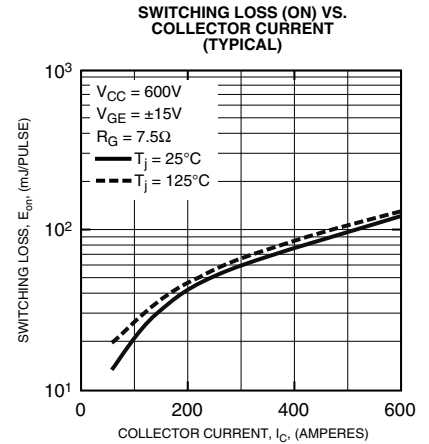
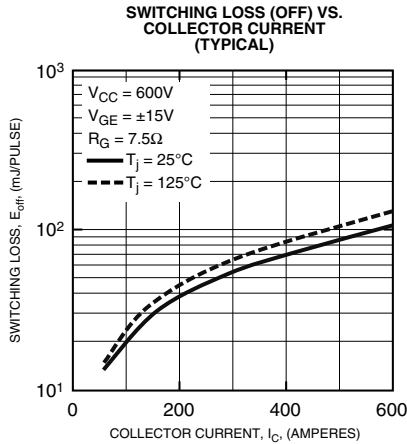
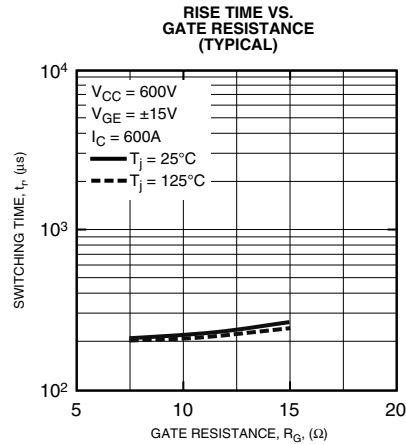



Powerex, Inc., 200 E. Hillis Street, Youngwood, Pennsylvania 15697-1800 (724) 925-7272

**MG600Q2YS60A**  
**Dual IGBTMOD™**  
**Compact IGBT Series Module**  
 600 Amperes/1200 Volts

**REVERSE BIAS SAFE OPERATION AREA (TYPICAL)**

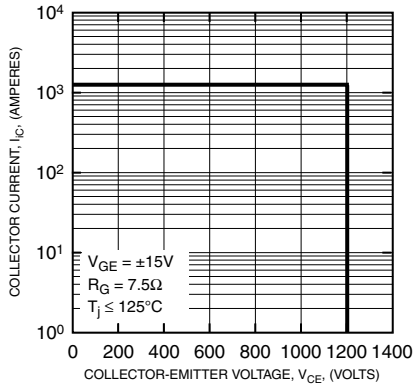

**COLLECTOR-EMITTER VOLTAGE VS. GATE CHARGE (TYPICAL)**

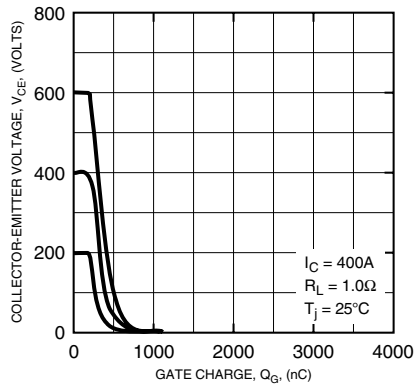

**GATE-EMITTER VOLTAGE VS. GATE CHARGE (TYPICAL)**

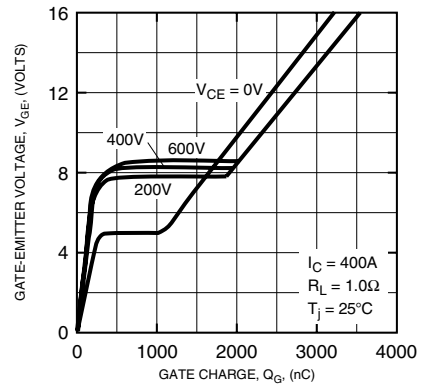

**SHORT CIRCUIT SAFE OPERATING AREA (TYPICAL)**

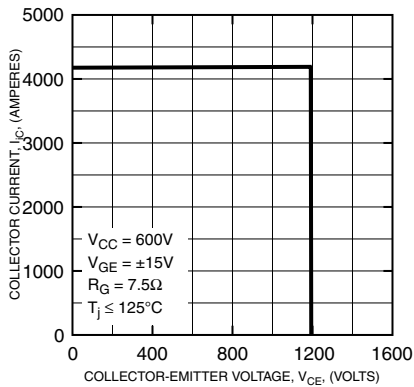

**SHORT CIRCUIT PULSE WIDTH VS. GATE RESISTANCE (TYPICAL)**

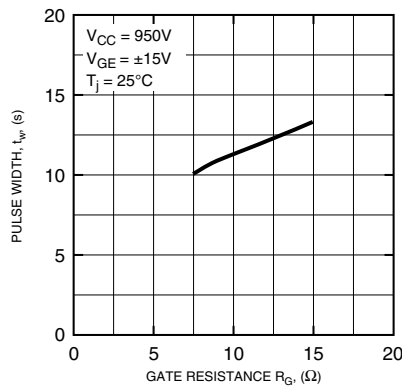

**TRANSIENT THERMAL IMPEDANCE CHARACTERISTICS (IGBT)**

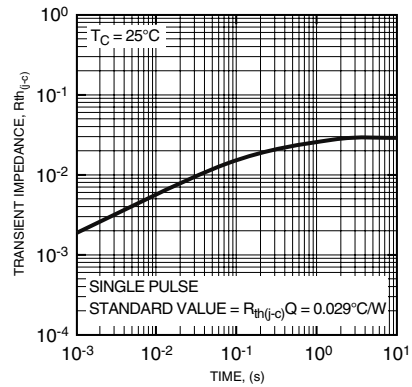

**TRANSIENT THERMAL IMPEDANCE CHARACTERISTICS (FWDI)**

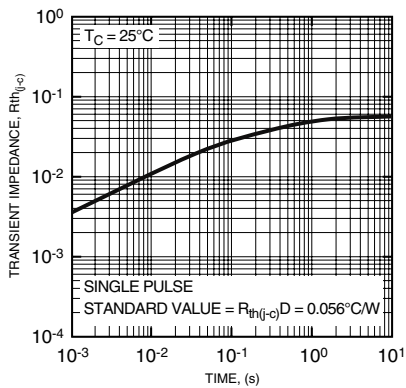

This datasheet is downloaded from:

[www.igbtexpress.com](http://www.igbtexpress.com)

IGBT Express, your specialist and sourcing expert when it comes to finding modules you need .

