

MITSUBISHI TRANSISTOR MODULES  
**QM30E2Y/E3Y-2H**

MEDIUM POWER SWITCHING USE  
 INSULATED TYPE

QM30E2Y/E3Y-2H



- **IC** Collector current ..... **30A**
- **V<sub>CEX</sub>** Collector-emitter voltage ..... **1000V**
- **h<sub>FE</sub>** DC current gain ..... **75**
- **Insulated Type**
- **UL Recognized**

Yellow Card No. E80276 (N)  
 File No. E80271

**APPLICATION**

DC chopper, DC motor controllers, Inverters

**OUTLINE DRAWING & CIRCUIT DIAGRAM**

Dimensions in mm

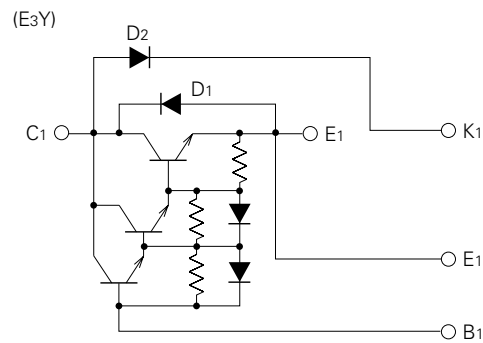
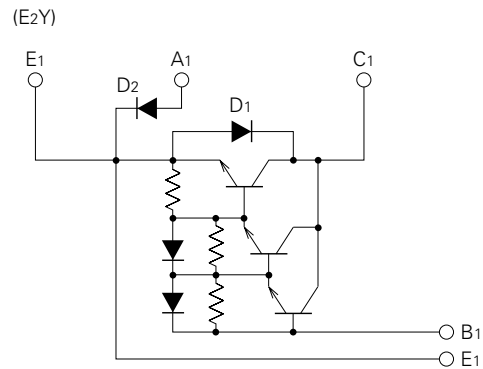
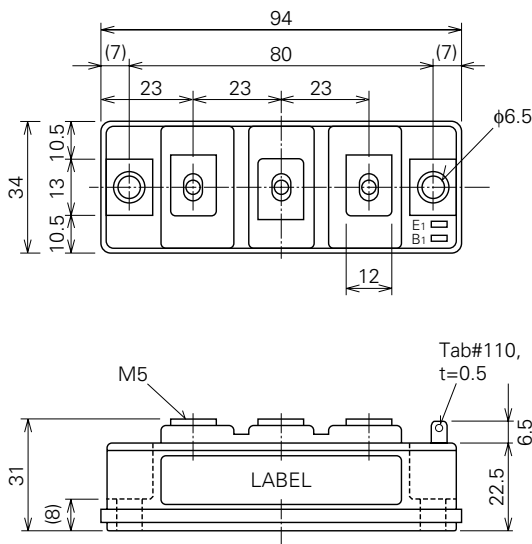

**QM30E2Y/E3Y-2H**

**MEDIUM POWER SWITCHING USE  
INSULATED TYPE**

**ABSOLUTE MAXIMUM RATINGS** (Transistor part including D1,  $T_j=25^\circ\text{C}$ )

Symbol	Parameter	Conditions	Ratings	Unit
VCEX (SUS)	Collector-emitter voltage	$I_C=1\text{A}$ , $V_{EB}=2\text{V}$	1000	V
VCEX	Collector-emitter voltage	$V_{EB}=2\text{V}$	1000	V
VCBO	Collector-base voltage	Emitter open	1000	V
VEBO	Emitter-base voltage	Collector open	7	V
$I_C$	Collector current	DC	30	A
$-I_C$	Collector reverse current	DC (forward diode current)	30	A
$P_C$	Collector dissipation	$T_C=25^\circ\text{C}$	310	W
$I_B$	Base current	DC	2	A
$-I_{CSM}$	Surge collector reverse current (forward diode current)	Peak value of one cycle of 60Hz (half wave)	300	A

**ABSOLUTE MAXIMUM RATINGS** (Diode part (D2),  $T_j=25^\circ\text{C}$ )

Symbol	Parameter	Conditions	Ratings	Unit
VRRM	Repetitive peak reverse voltage		1000	V
VRSM	Non-repetitive peak reverse voltage		1100	V
$V_R$ (DC)	DC reverse voltage		800	V
$I_{DC}$	DC current	DC circuit, resistive, inductive load	30	A
$I_{FSM}$	Surge (non-repetitive) forward current	Peak value of one cycle of 60Hz (half wave)	600	A
$I^2t$	$I^2t$ for fusing	Value for one cycle of surge current	$1.5 \times 10^3$	$\text{A}^2\text{s}$

**ABSOLUTE MAXIMUM RATINGS** (Common)

Symbol	Parameter	Conditions	Ratings	Unit
$T_j$	Junction temperature		$-40 \sim +150$	$^\circ\text{C}$
$T_{stg}$	Storage temperature		$-40 \sim +125$	$^\circ\text{C}$
$V_{iso}$	Isolation voltage	Charged part to case, AC for 1 minute	2500	V
—	Mounting torque	Main terminal screw M5	1.47~1.96	N·m
			15~20	kg·cm
		Mounting screw M6	1.96~2.94	N·m
			20~30	kg·cm
—	Weight	Typical value	210	g

**ELECTRICAL CHARACTERISTICS** (Transistor part including D1,  $T_j=25^\circ\text{C}$ )

Symbol	Parameter	Test conditions	Limits			Unit
			Min.	Typ.	Max.	
$I_{CEX}$	Collector cutoff current	$V_{CE}=1000\text{V}$ , $V_{EB}=2\text{V}$	—	—	1.0	mA
$I_{CBO}$	Collector cutoff current	$V_{CB}=1000\text{V}$ , Emitter open	—	—	1.0	mA
$I_{EBO}$	Emitter cutoff current	$V_{EB}=7\text{V}$	—	—	200	mA
$V_{CE(sat)}$	Collector-emitter saturation voltage	$I_C=30\text{A}$ , $I_B=0.6\text{A}$	—	—	2.5	V
$V_{BE(sat)}$	Base-emitter saturation voltage		—	—	3.5	V
$-V_{CEO}$	Collector-emitter reverse voltage	$-I_C=30\text{A}$ (diode forward voltage)	—	—	1.8	V
$h_{FE}$	DC current gain	$I_C=30\text{A}$ , $V_{CE}=2.8\text{V}/5\text{V}$	75/100	—	—	—
$t_{on}$	Switching time	$V_{CC}=600\text{V}$ , $I_C=30\text{A}$ , $I_{B1}=-I_{B2}=0.6\text{A}$	—	—	2.5	$\mu\text{s}$
$t_s$			—	—	15	$\mu\text{s}$
$t_f$			—	—	3.0	$\mu\text{s}$
$R_{th(j-c)Q}$	Thermal resistance (junction to case)	Transistor part	—	—	0.4	$^\circ\text{C}/\text{W}$
$R_{th(j-c)R}$		Diode part	—	—	1.5	$^\circ\text{C}/\text{W}$
$R_{th(c-f)}$	Contact thermal resistance (case to fin)	Conductive grease applied	—	—	0.15	$^\circ\text{C}/\text{W}$

# QM30E2Y/E3Y-2H

MEDIUM POWER SWITCHING USE  
INSULATED TYPE

## ELECTRICAL CHARACTERISTICS (Diode part (D2), $T_j=25^\circ\text{C}$ )

Symbol	Parameter	Test conditions	Limits			Unit
			Min.	Typ.	Max.	
$I_{RRM}$	Repetitive peak reverse current	$V_R=V_{RRM}, T_j=150^\circ\text{C}$	—	—	10	mA
$V_{FM}$	Forward voltage	$I_F=30\text{A}$	—	—	1.5	V
$t_{rr}$	Reverse recovery time	$I_F=30\text{A}, di/dt=-60\text{A}/\mu\text{s}, V_R=600\text{V}, T_j=150^\circ\text{C}$	—	—	1.0	$\mu\text{s}$
$Q_{rr}$	Reverse recovery charge		—	—	20	$\mu\text{C}$
$R_{th(j-c)}$	Thermal resistance	Junction to case	—	—	1.2	$^\circ\text{C}/\text{W}$
$R_{th(c-f)}$	Contact thermal resistance	Conductive grease applied (case to fin)	—	—	0.15	$^\circ\text{C}/\text{W}$

## PERFORMANCE CURVES

**COMMON EMITTER OUTPUT CHARACTERISTICS (TYPICAL)**

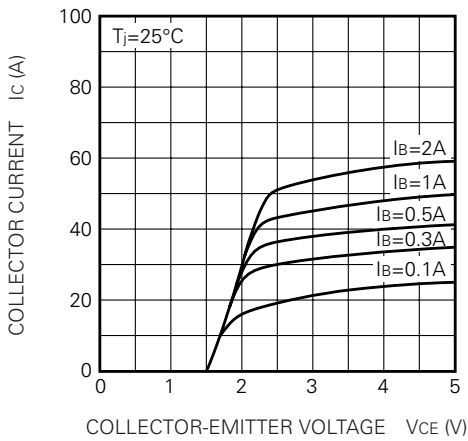

**DC CURRENT GAIN VS. COLLECTOR CURRENT (TYPICAL)**

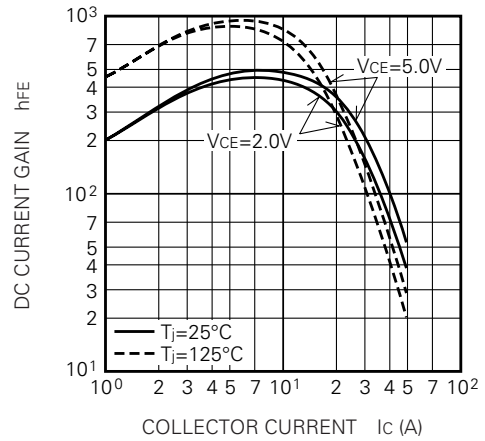

**COMMON EMITTER INPUT CHARACTERISTIC (TYPICAL)**

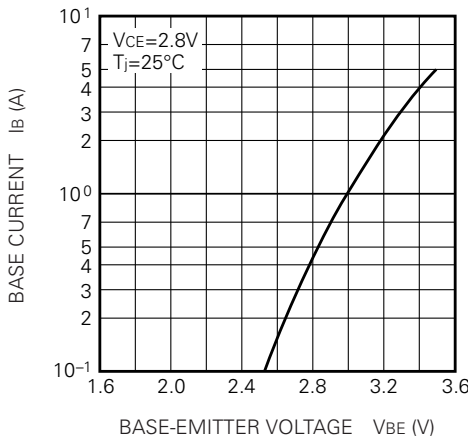

**SATURATION VOLTAGE CHARACTERISTICS (TYPICAL)**

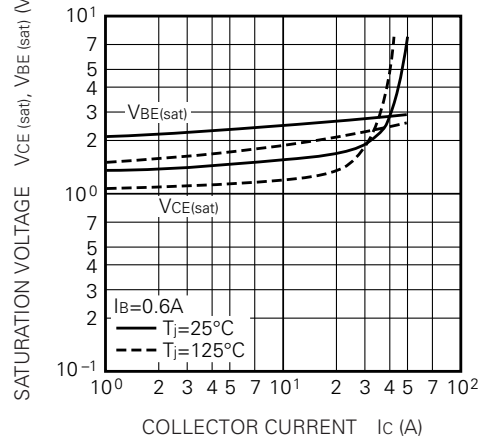

QM30E2Y/E3Y-2H

MEDIUM POWER SWITCHING USE  
INSULATED TYPE

COLLECTOR-EMITTER SATURATION VOLTAGE (TYPICAL)

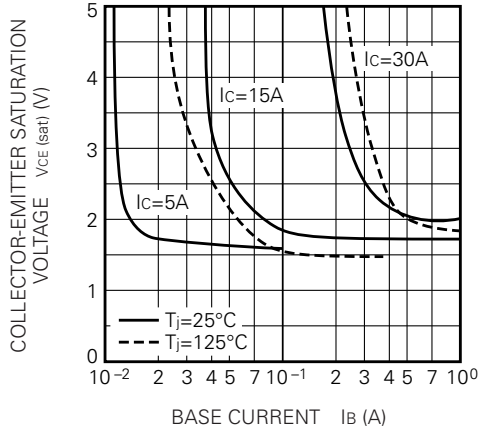

SWITCHING TIME VS. COLLECTOR CURRENT (TYPICAL)

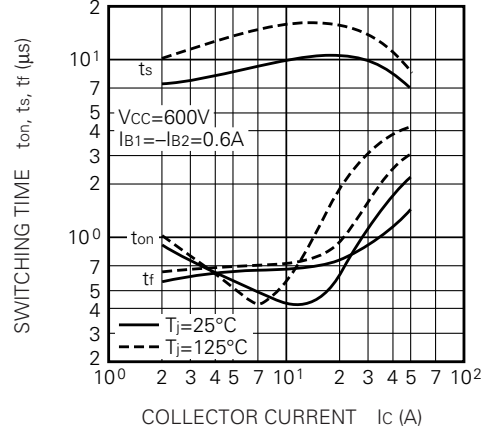

SWITCHING TIME VS. BASE CURRENT (TYPICAL)

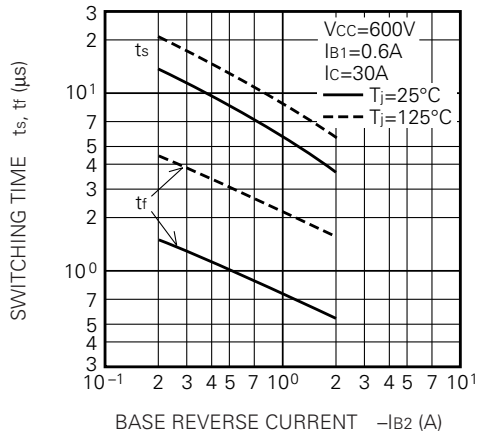

REVERSE BIAS SAFE OPERATING AREA

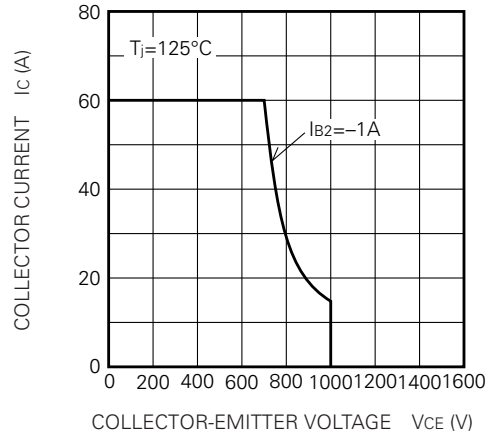

FORWARD BIAS SAFE OPERATING AREA

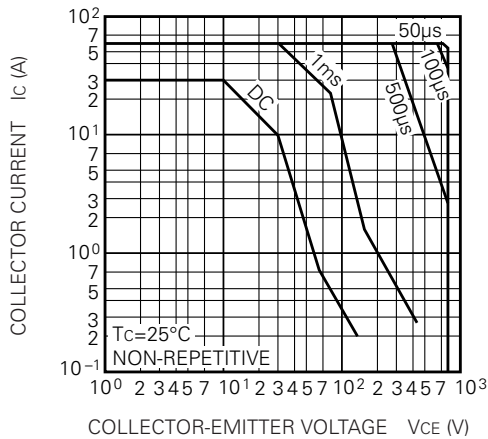

DERATING FACTOR OF F. B. S. O. A.

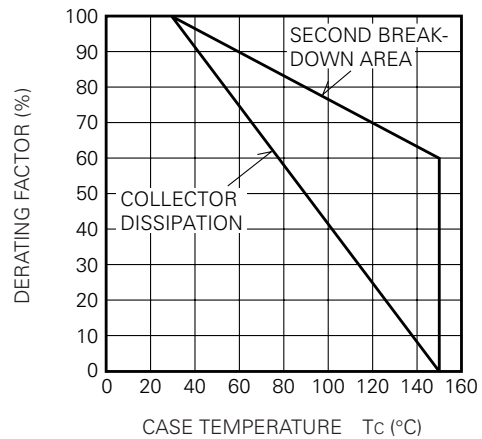

QM30E2Y/E3Y-2H

MEDIUM POWER SWITCHING USE  
INSULATED TYPE

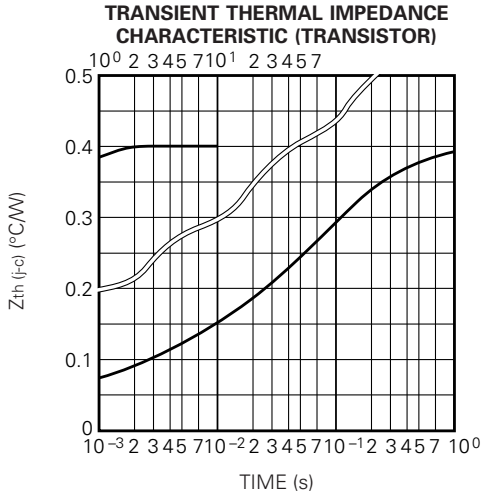

**PERFORMANCE CURVES (Diode part (D1))**

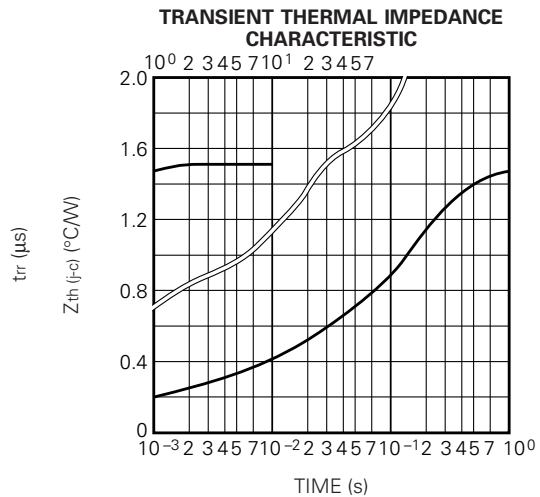
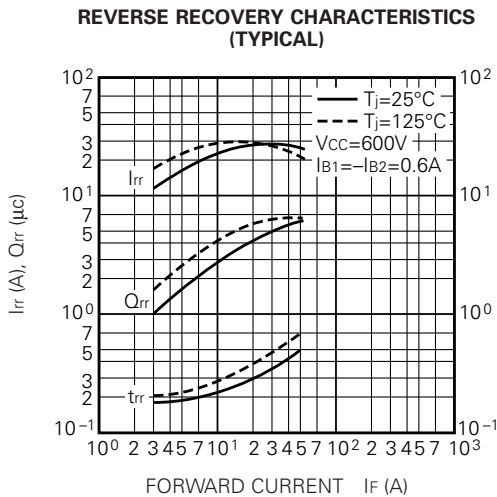
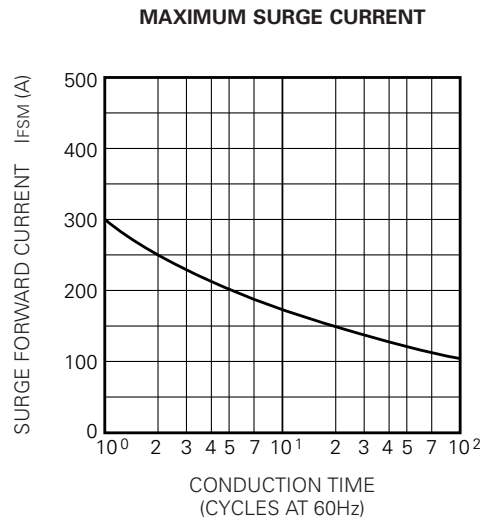
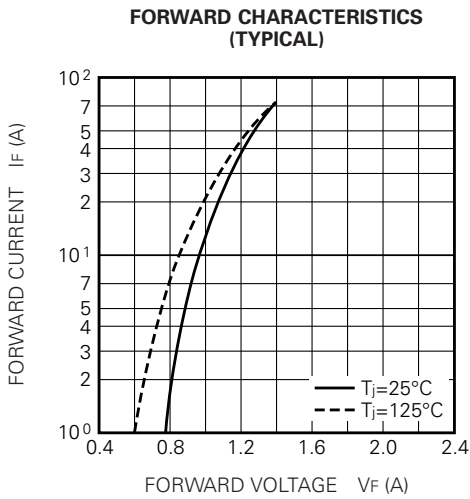

QM30E2Y/E3Y-2H

MEDIUM POWER SWITCHING USE  
INSULATED TYPE

PERFORMANCE CURVES (Diode part (D2))

MAXIMUM FORWARD CHARACTERISTIC

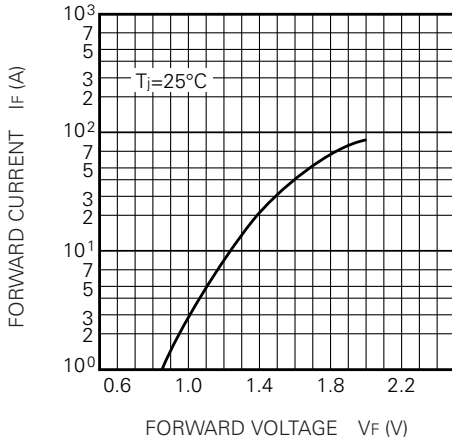

TRANSIENT THERMAL IMPEDANCE CHARACTERISTIC

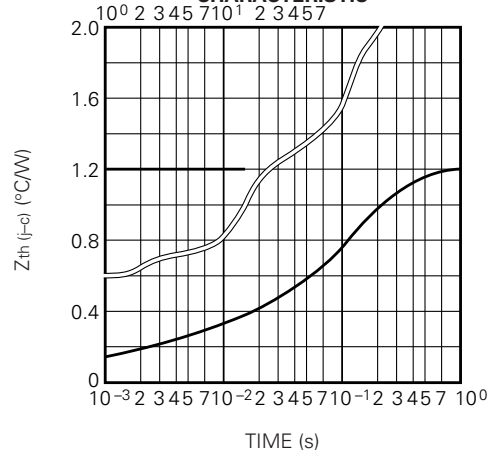

MAXIMUM SURGE CURRENT

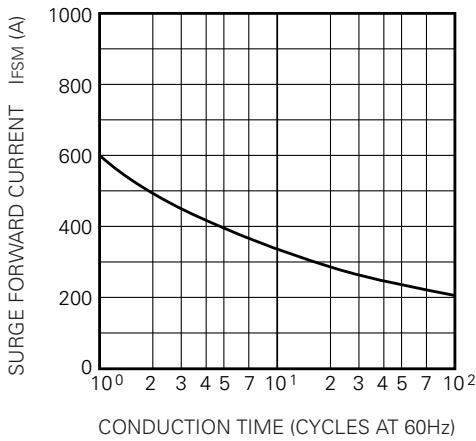

REVERSE RECOVERY CHARACTERISTICS (VS. I<sub>F</sub>) (TYPICAL)

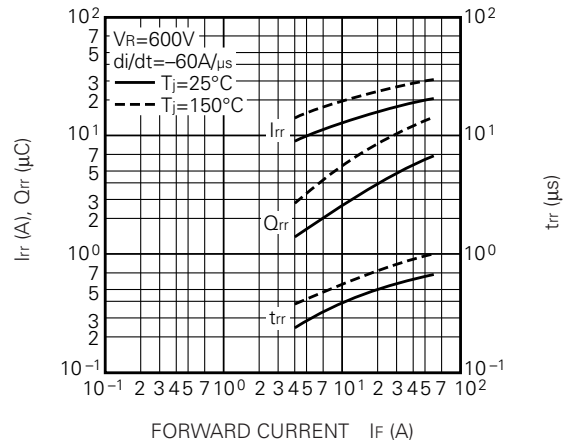

REVERSE RECOVERY CHARACTERISTICS (VS. di/dt) (TYPICAL)

